



OS&Y Gate Valve Supervisory Switch

Fig. RDOSY2N

General Description

The RDOSY2N Supervisory limit switch is used to monitor the open position of an Outside Screw and Yoke (OS&Y) type gate valve. Switch should be mounted so as not to interfere with the normal operation of the valve and adjusted to operate within two revolutions of the valve control or when the stem has moved no more than one-fifth of the distance from its normal position. The mechanism is contained in a weatherproof die cast metal housing that provides a side entrance for 1/2" conduit and incorporates the necessary facilities for attachment to the valve. A grounding provision is provided. The switch assembly includes two switches, each with a rated capacity of 10 Amp @ 125/250VAC and 2.5 Amp @ 24VDC. The cover contains tamper-resistant screws for which a security wrench is provided. The RDOSY2N is UL listed and FM approved for indoor or outdoor use.

Features

- NEMA 3R-rated enclosure
- User-friendly mounting bracket fits newer valve yokes
- Single side conduit entry does not require right angle fittings
- Adjustable length actuator eliminates the need for cutting the shaft
- Accommodates up to 12 AWG wire
- Three position switch monitors vandal and valve close signals
- Two SPDT contacts are enclosed in a durable terminal block for added strength
- 100 percent synchronization activates both alarm panel and local bell simultaneously

Robust Construction: The RDOSY2N consists of a rugged housing, intended for indoor and outdoor use. When installed with the actuator in the vertical position, the RDOSY2N is NEMA 3R rated per UL.

Application Flexibility: The RDOSY2N features a user-friendly mounting bracket and adjustable shaft to permit mounting to most OS&Y valves, ranging in size from 1" to 12". Its right angle design and wide bracket span provides maximum clearance for valve components, to accommodate troublesome valves.

Simplified Operation: Installation is made easier with the RDOSY2N's single side conduit entrance. By providing a direct conduit pathway to the electrical source, right angle fittings are not required. Installation is further simplified by the RDOSY2N's adjustable length actuator, which eliminates the need for cutting the shaft.

Consistent Performance: The RDOSY2N is equipped with tamper resistant cover screws to prevent unauthorized entry. Inside, two sets of SPDT (Form C) synchronized switches are enclosed in a durable terminal block to assure reliable performance.



Specifications

Overall Switch Dimensions	146mm x 89mm x 82mm (5 3/4" x 3 1/2" x 3 1/4")
Shipping Weight	1.3 kg (2.8 lbs.)
Operating Temperature Range	0°C to 49°C (32°F to 120°F) NOTE: The OSY2 will operate from -40°C to 49°C (-40°F to 120°F); however UL does not test control valve supervisory switches below 0°C (32°F).
Maximum Stem Extension	67mm (2 5/8")
Bracket Span	57mm x 171mm x 25mm (2 1/4" x 6 3/4" x 1")
Conduit Entrances	One single side open for 1/2" conduit
Contact Ratings	Two sets of SPDT (Form C) 10.0 A @ 125/250V AC; 2.5 A @ 6/12/24V DC
Enclosure Rating	UL indoor/outdoor NEMA 3R when mounted with the actuator vertical
Service Use	Automatic Sprinkler: NFPA 13 One or Two Family Dwelling: NFPA 13D Residential Occupancies up to 4 stories: NFPA 13R National Fire Alarm code: NFPA 72

OS&Y Gate Valve Supervisory Switch Fig. RDOSY2N

Electrical Connections

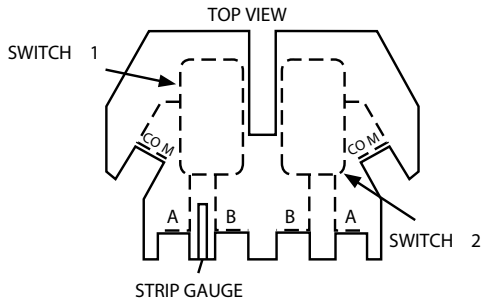

CONTACT RATINGS	
125/250 VAC	10 AMPS
24 VDC	2.5 AMPS

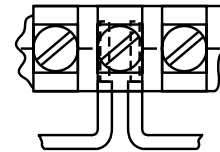
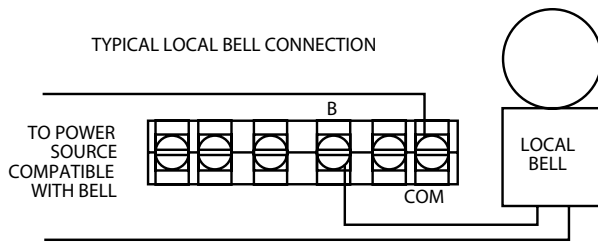
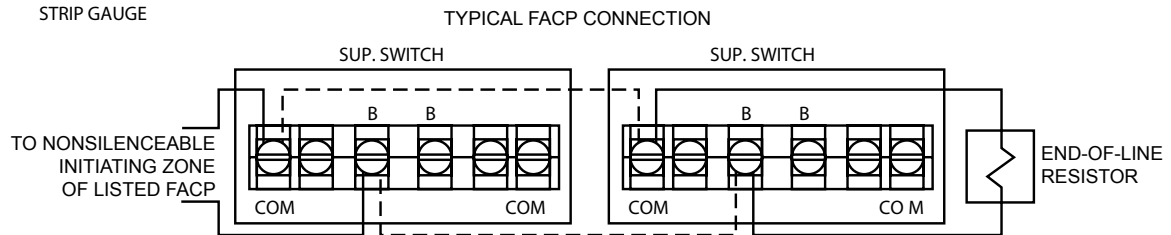

BREAK WIRE AS SHOWN FOR SUPERVISION OF CONNECTION. DO NOT ALLOW STRIPPED WIRE LEADS TO EXTEND BEYOND SWITCH HOUSING. DO NOT LOOP WIRES.

Mounting Positions

The following are examples of acceptable mounting positions:

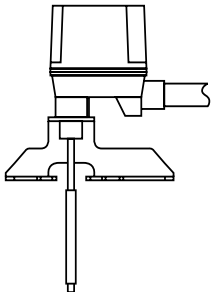

Actuator Vertical(Down)

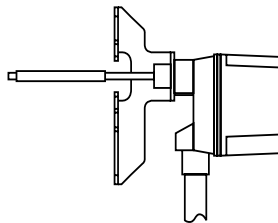

Actuator Horizontal

The following mounting position is not acceptable

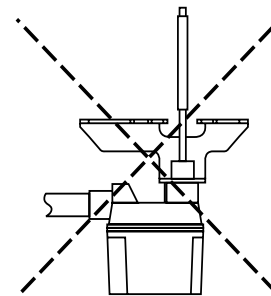

Actuator Vertical (Pointing Up)